

Name _____ Period _____ Date _____

Area of a Trapezoid

1) $A =$ _____

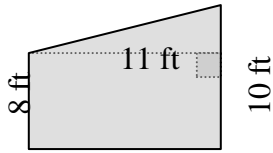

2) $A =$ _____

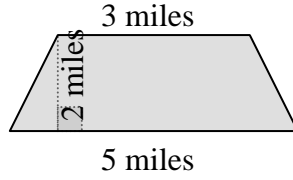

3) $A =$ _____

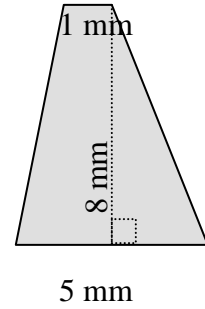

4) $A =$ _____

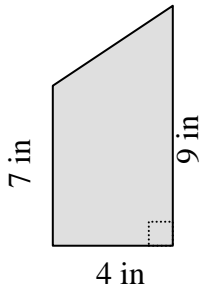

5) $A =$ _____

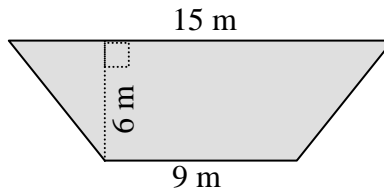

6) $A =$ _____

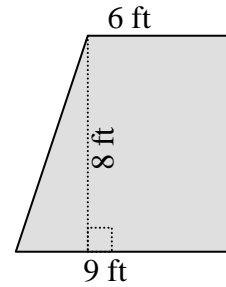

7) $A =$ _____

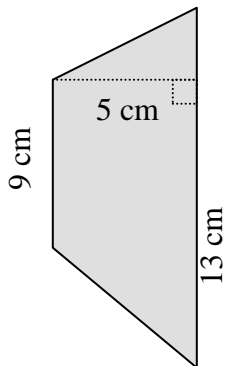

8) $A =$ _____

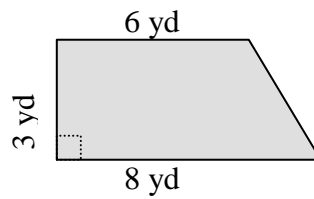

9) $A =$ _____

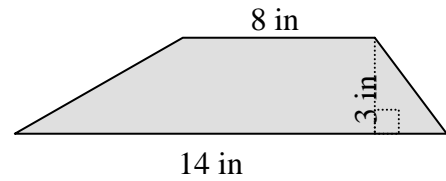

10) A=_____

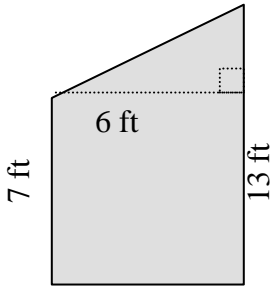

11) A=_____

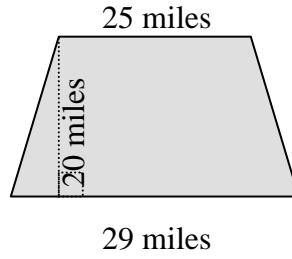

12) A=_____

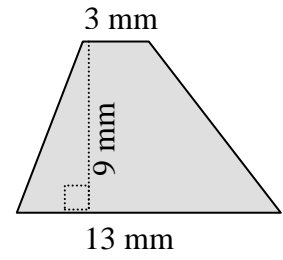

13) A=_____

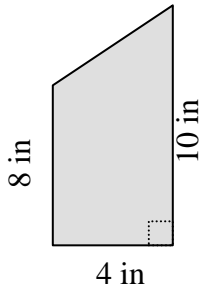

14) A=_____

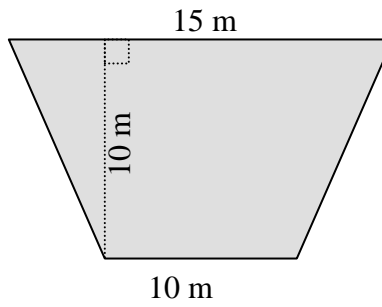

15) A=_____

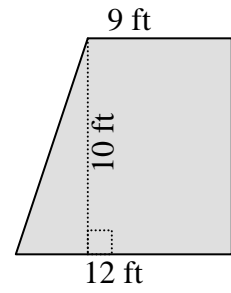

16) A=_____

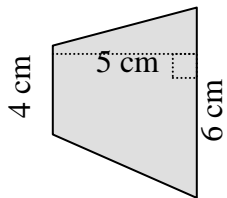

17) A=_____

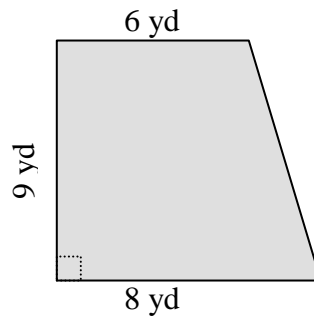

18) A=_____

